

**LED工矿灯**  
**LED High Bay Light**

**190LM/W**

**SPECIFICATIONS**

**中英文规格书**



**5 Years Warranty**

**CE RoHS**

## UFO09 60W-150W

## 参数/Specification

型号/Model	SA-UFOA00-60W	SA-UFOA00-80W	SA-UFOA00-100W	SA-UFOA00-150W
功率因素/PF	>0.95			
输入电压/Input Voltage (V)	100-277VAC			
显色指数/ CRI	Ra70	Ra80	Ra70	Ra80
光效/ Efficacy (lm/W)± %	190	180	190	180
光通量/ Lumen output ±	11400	10800	15200	14400
色温/ CCT (K)	2700-6500K			
调光方式/ Dimming	无调光/0~10V调光/ (Non-Dimming/0~10V Dimming)			
发光角度/ Beam angle	60°/90°/120°			
主要材质/ Material	铝合金+PC (Aluminum+PC Lens)			
工作温度/ Operating Tempe	-30°C to 45°C			
工作湿度/ Humidity	10%-90%			
安装方式/ Installation	吊环安装/支架安装(Ring Mounted/Bracket Mounted)			
灯珠型号/ LED Type	SMD2835			
电源品牌/ Power Supply	强流明/崧盛/茂硕/飞利浦 (Stronglumen/Sosen/Moso/Philips)			
浪涌保护/ Surge Protection	4kV line-line, 6kV line-earth			
认证/ Certification	CE/RoHS			
IP等级/ IP Rate	IP65			
质保/ Warranty	5年 (5Years)			

## SA-UFOA00-XXXY-XXXX-B-Z[XX]

SA-UFO	A00	XXX	Y	XXXX	B	Z	XX
系列 Series	电压 Voltage	功率 Power	色温 CCT	角度 Lens	版本 Versions	控制方式 Control	安装方式 Mounting
SA-UFO	100-277V	60W 80W 100W 150W	N 3000K M 3500K L 4000K K 4500K C 5000K H 5700K	R060 表示 60° R090 表示 90° R120 表示 120°	"B" 第二代产品 (The two generation)	无感应, 运动感应 (Not Sensor, Motion Sensor)	吊环安装, 支架安装 (Blank Rings, BM Bracket)

描述 (Description):

型号名称说明(Model name description): SA-UFOA00-150Y-RXXX-B.

"SA" 表示公司生产的名称; ("SA" indicates the name of company producing the product)

"UFO" 表示该产品是LED工矿灯; ("UFO" indicates the product is a LED High Bay)

"A00" 表示输入电压是100-277VAC; ("A00" indicates the voltage is 100-277VAC)

"150" 表示该产品的功率; ("150" indicates the power of the product)

"Y" 表示该产品的色温; ("Y" indicates the colour temperature of the product)

"Y" 可以是 N=3000K, M=3500K, L=4000K, K=4500K, C=5000K, H=5700K 代表不同的色温值;

"XXXX" 表示发光角度, 它可以是R060,R090,R120; ("XXXX" represent light angle, it can be R060,R090,R120)

"B" 表示该产品的版本规格; ("B" indicates the shape size)

"Z" 表示产品控制方式, "Z" 可以是N=没有感应, M=运动感应;

("Z" indicates the Intelligent Control,Where the "Z" can be N=Not Sensor, M=Motion Sensor)

## UFO09 60W-150W

## 包装/Packing

产品型号 Model No.	功率 Power	尺寸 (毫米) Size(mm)	包装尺寸 (毫米) Carton Size(mm)	毛重/1个±0.2千克) G.W./1PCS±0.2KG
SA-UFOA00-60Y-XXXX-B	60W	Φ240xH154	L290xW290xH165	2.2KG
SA-UFOA00-80Y-XXXX-B	80W	Φ285xH156	L320xW320xH185	2.7KG
SA-UFOA00-100Y-XXXX-B	100W	Φ285xH156	L320xW320xH185	2.8KG
SA-UFOA00-150Y-XXXX-B	150W	Φ325xH172	L380xW380xH185	3.4KG

## 尺寸图/Dimensions(unit: mm)

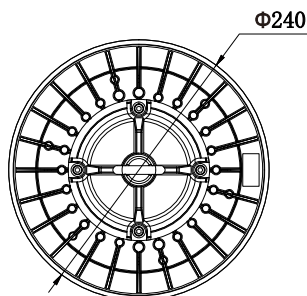
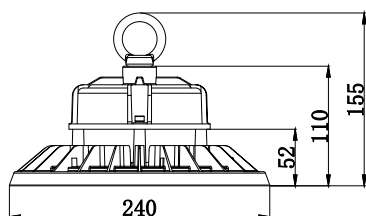

60W

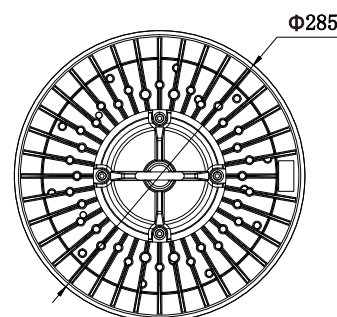
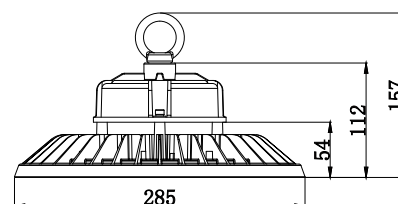

80/100W

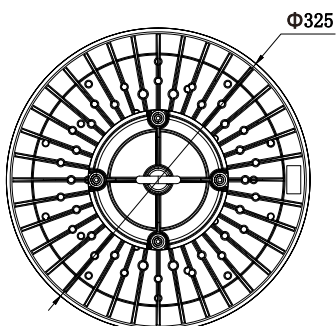
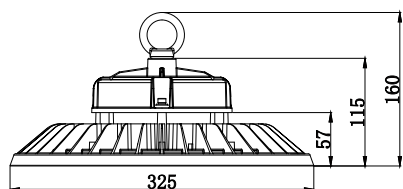

150W

UFO09 60W-150W

## 结构性能/Structure Performance

尺寸/Dimension: LxHxW(mm)	Φ240xH155/Φ285xH157/Φ325xH160
壳体/ Housing:	铝合金/ Aluminum
面罩/ Cover:	PC透镜/PC Lens
电线长度/ Cable Length:	300mm
IP等级/ IP Rate:	IP 65
IP等级/ IK Rate:	IK 10

## 爆炸图/Structure drawing

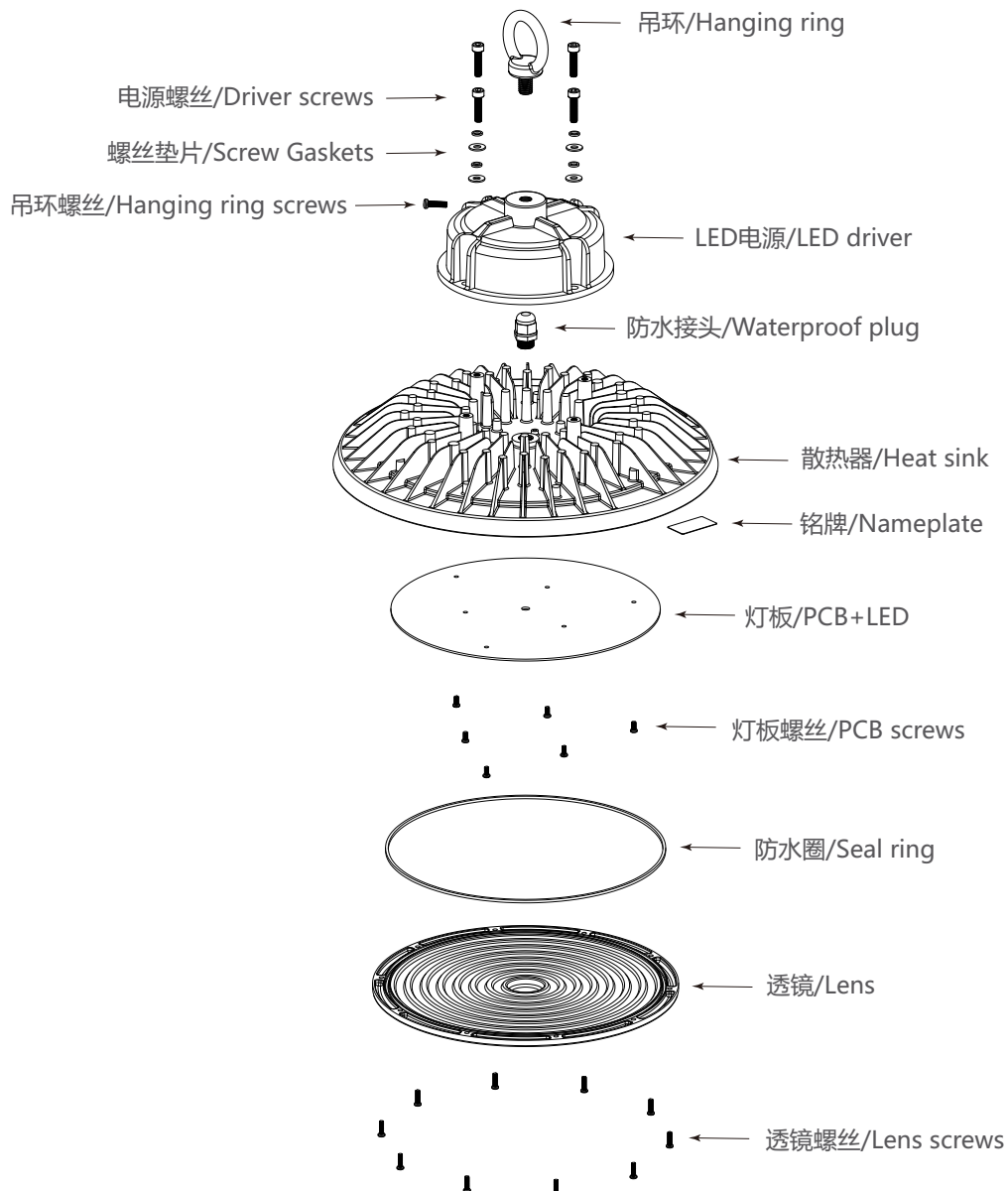

UFO09 60W-150W

# 发光角度/Beam angle

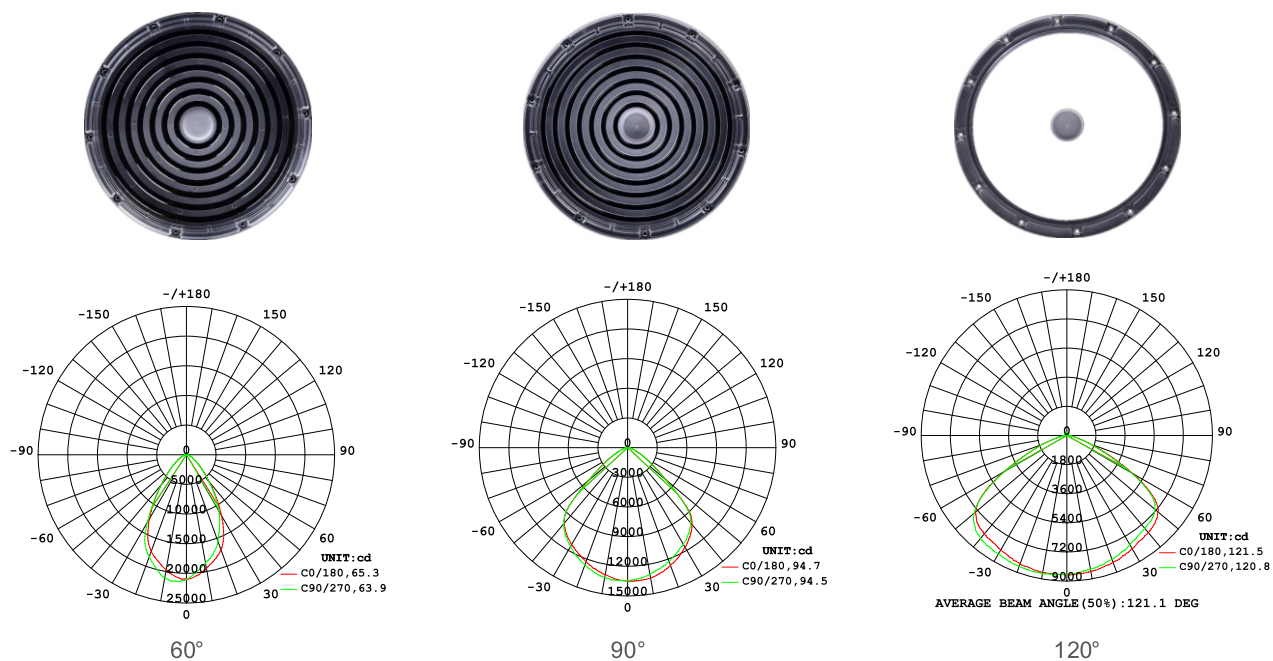

# 安装方式/Installation

## 1-吊环安装/Ring mounted

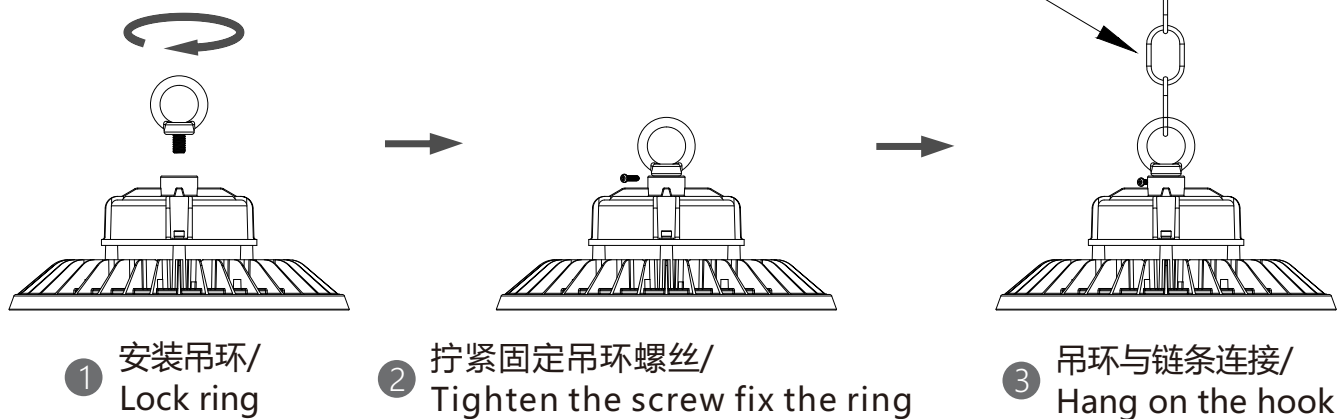

## 2-支架安装/Bracket mounted

